

REVISIONS

LTR	DESCRIPTION	DATE (YR-MO-DA)	APPROVED
A	Changes in accordance with NOR 5962-R086-97. - JB	96-11-19	Monica L. Poelking
B	Changes in accordance with NOR 5962-R364-97. - CFS	97-06-19	Monica L. Poelking
C	Add limit for linear energy threshold (LET) with no latch-up in section 1.5. Update the boilerplate to the requirements of MIL-PRF-38535. Editorial changes throughout. - TVN	07-04-25	Thomas M. Hess
D	To correct switching waveforms input/output test limits to figure 4. Add test equivalent circuits and footnote 5 to figure 4. Delete class M requirements throughout. - MAA	13-01-25	Thomas M. Hess
E	Update quiescent supply current (I _{DDQ}) limit to table IA. - MAA	17-10-30	Thomas M. Hess
F	Update boilerplate paragraphs to current MIL-PRF-38535 requirements. - TTM	20-03-10	Muhammad A. Akbar
G	Add RHA devices with TID level G and die 9B in Figure B-1. Discontinued RHA TID level H devices associated with die 9A. - TTM	20-09-18	Muhammad A. Akbar



REV																				
SHEET																				
REV	G	G	G	G	G	G	G	G	G											
SHEET	15	16	17	18	19	20	21	22	23											
REV STATUS OF SHEETS	REV			G	G	G	G	G	G	G	G	G	G	G	G	G	G	G	G	
	SHEET			1	2	3	4	5	6	7	8	9	10	11	12	13	14			
PMIC N/A	PREPARED BY Thanh V. Nguyen									<p align="center">DLA LAND AND MARITIME COLUMBUS, OHIO 43218-3990 https://www.dla.mil/LandandMaritime</p>										
<p align="center">STANDARD MICROCIRCUIT DRAWING</p> <p>THIS DRAWING IS AVAILABLE FOR USE BY ALL DEPARTMENTS AND AGENCIES OF THE DEPARTMENT OF DEFENSE</p> <p align="center">AMSC N/A</p>	CHECKED BY Thanh V. Nguyen																			
	APPROVED BY Monica L. Poelking									<p>MICROCIRCUIT, DIGITAL, RADIATION HARDENED, ADVANCED CMOS, OCTAL BUFFER/LINE DRIVER WITH THREE-STATE OUTPUTS, TTL COMPATIBLE INPUTS, MONOLITHIC SILICON</p>										
	DRAWING APPROVAL DATE 96-03-11																			
	REVISION LEVEL G									SIZE A	CAGE CODE 67268	5962-96571								
										SHEET 1 OF 23										

1. SCOPE

1.1 Scope. This drawing documents two product assurance class levels consisting of high reliability (device class Q) and space application (device class V). A choice of case outlines and lead finishes are available and are reflected in the Part or Identifying Number (PIN). When available, a choice of Radiation Hardness Assurance (RHA) levels is reflected in the PIN.

1.2 PIN. The PIN is as shown in the following example:

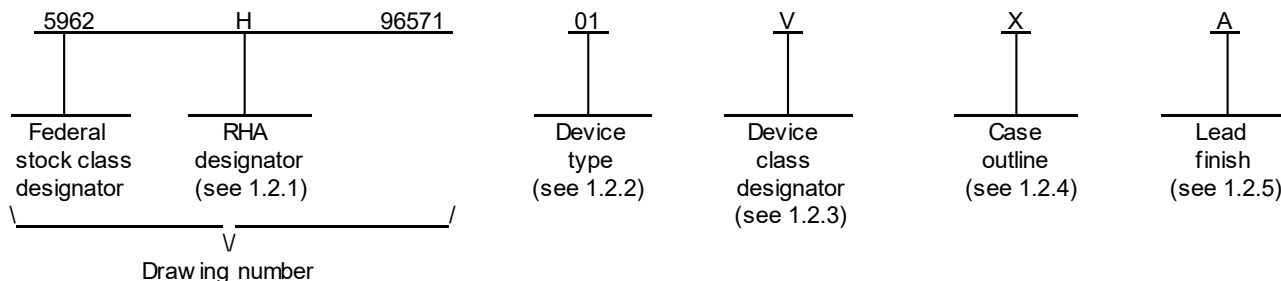

1.2.1 RHA designator. Device classes Q and V RHA marked devices meet the MIL-PRF-38535 specified RHA levels and are marked with the appropriate RHA designator. A dash (-) indicates a non-RHA device.

1.2.2 Device type(s). The device type(s) identify the circuit function as follows:

<u>Device type</u>	<u>Generic number</u>	<u>Circuit function</u>
01	54ACTS244	Radiation hardened, octal buffer/line driver with three-state outputs, TTL compatible inputs

1.2.3 Device class designator. The device class designator is a single letter identifying the product assurance level as follows:

<u>Device class</u>	<u>Device requirements documentation</u>
Q or V	Certification and qualification to MIL-PRF-38535

1.2.4 Case outline(s). The case outline(s) are as designated in MIL-STD-1835 and as follows:

<u>Outline letter</u>	<u>Descriptive designator</u>	<u>Terminals</u>	<u>Package style</u>
R	GDIP1-T20 or CDIP2-T20	20	Dual-in-line
X	CDFP4-F20	20	Flat pack

1.2.5 Lead finish. The lead finish is as specified in MIL-PRF-38535 for device classes Q and V.

STANDARD MICROCIRCUIT DRAWING DLA LAND AND MARITIME COLUMBUS, OHIO 43218-3990	SIZE A		5962-96571
		REVISION LEVEL G	SHEET 2

1.3 Absolute maximum ratings. 1/ 2/ 3/

Supply voltage range (V _{DD})	-0.3 V dc to +7.0 V dc
DC input voltage range (V _{IN}).....	-0.3 V dc to V _{DD} + 0.3 V dc
DC output voltage range (V _{OUT})	-0.3 V dc to V _{DD} + 0.3 V dc
DC input current, any one input (I _{IN}).....	±10 mA
Latch-up immunity current (I _{LU}).....	±150 mA
Storage temperature range (T _{STG}).....	-65°C to +150°C
Lead temperature (soldering, 5 seconds).....	+300°C
Thermal resistance, junction-to-case (θ _{JC}).....	See MIL-STD-1835
Junction temperature (T _J).....	+175°C
Maximum power dissipation (P _D).....	1.0 W

1.4 Recommended operating conditions. 2/ 3/

Supply voltage range (V _{DD})	+4.5 V dc to +5.5 V dc
Input voltage range (V _{IN}).....	0.0 V dc to V _{DD}
Output voltage range (V _{OUT}).....	0.0 V dc to V _{DD}
Maximum input rise or fall time at V _{DD} = 4.5 V (t _r , t _f).....	1 ns/V 4/
Case operating temperature range (T _C).....	-55°C to +125°C

1.5 Radiation features. 5/

Maximum total dose available (dose rate = 50 – 300 Rad (Si)/s).....	1M Rad (Si)
Single event phenomenon (SEP):	
No SEU occurs at effective LET (see 4.4.4.4).....	≤ 80 MeV/(mg/cm ²) 6/
No SEL occurs at effective LET (see 4.4.4.4).....	≤ 120 MeV/(mg/cm ²) 6/
Dose rate upset (20 ns pulse).....	≥ 1 x 10 ⁹ Rad (Si)/s 6/
Dose rate induced latch-up.....	None 6/
Dose rate survivability.....	1 x 10 ¹² Rad(Si)/s 6/

-
- 1/ Stresses above the absolute maximum rating may cause permanent damage to the device. Extended operation at the maximum levels may degrade performance and affect reliability.
 - 2/ Unless otherwise specified, all voltages are referenced to V_{SS}.
 - 3/ The limits for the parameters specified herein shall apply over the full specified V_{DD} range and case temperature range of -55°C to +125°C unless otherwise specified.
 - 4/ Derate system propagation delays by difference in rise time to switch point for t_r or t_f > 1 ns/V.
 - 5/ Radiation testing is performed on the standard evaluation circuit.
 - 6/ Limits are guaranteed by design or process but not production tested unless specified by the customer through the purchase order or contract.

STANDARD MICROCIRCUIT DRAWING DLA LAND AND MARITIME COLUMBUS, OHIO 43218-3990	SIZE A	REVISION LEVEL G	5962-96571 SHEET 3
--	------------------	----------------------------	--

2. APPLICABLE DOCUMENTS

2.1 Government specification, standards, and handbooks. The following specification, standards, and handbooks form a part of this drawing to the extent specified herein. Unless otherwise specified, the issues of these documents are those cited in the solicitation or contract.

DEPARTMENT OF DEFENSE SPECIFICATION

MIL-PRF-38535 - Integrated Circuits, Manufacturing, General Specification for.

DEPARTMENT OF DEFENSE STANDARDS

MIL-STD-883 - Test Method Standard Microcircuits.
 MIL-STD-1835 - Interface Standard Electronic Component Case Outlines.

DEPARTMENT OF DEFENSE HANDBOOKS

MIL-HDBK-103 - List of Standard Microcircuit Drawings.
 MIL-HDBK-780 - Standard Microcircuit Drawings.

(Copies of these documents are available online at <https://quicksearch.dla.mil/>.)

2.2 Non-Government publications. The following document(s) form a part of this document to the extent specified herein. Unless otherwise specified, the issues of the documents are the issues of the documents cited in the solicitation or contract.

ASTM INTERNATIONAL (ASTM)

ASTM F1192 - Standard Guide for the Measurement of Single Event Phenomena (SEP) Induced by Heavy Ion Irradiation of Semiconductor Devices.

(Copies of these documents are available online at <https://www.astm.org/>.)

(Non-Government standards and other publications are normally available from the organizations that prepare or distribute the documents. These documents may also be available in or through libraries or other informational services.)

2.3 Order of precedence. In the event of a conflict between the text of this drawing and the references cited herein, the text of this drawing takes precedence. Nothing in this document, however, supersedes applicable laws and regulations unless a specific exemption has been obtained.

3. REQUIREMENTS

3.1 Item requirements. The individual item requirements for device classes Q and V shall be in accordance with MIL-PRF-38535 and as specified herein or as modified in the device manufacturer's Quality Management (QM) plan. The modification in the QM plan shall not affect the form, fit, or function as described herein.

3.1.1 Microcircuit die. For the requirements of microcircuit die, see appendix A to this document.

3.2 Design, construction, and physical dimensions. The design, construction, and physical dimensions shall be as specified in MIL-PRF-38535 and herein for device classes Q and V or MIL-PRF-38535, appendix A and herein for device class M.

3.2.1 Case outlines. The case outlines shall be in accordance with 1.2.4 herein.

3.2.2 Terminal connections. The terminal connections shall be as specified on figure 1.

3.2.3 Truth table. The truth table shall be as specified on figure 2.

3.2.4 Logic diagram. The logic diagram shall be as specified on figure 3.

STANDARD MICROCIRCUIT DRAWING DLA LAND AND MARITIME COLUMBUS, OHIO 43218-3990	SIZE A		5962-96571
		REVISION LEVEL G	SHEET 4

3.2.5 Switching waveforms and test circuit. The switching waveforms and test circuit shall be as specified on figure 4.

3.2.6 Radiation exposure circuit. The radiation exposure circuit shall be maintained by the manufacturer under document revision level control and shall be made available to the preparing and acquiring activity upon request.

3.3 Electrical performance characteristics and postirradiation parameter limits. Unless otherwise specified herein, the electrical performance characteristics and post irradiation parameter limits are as specified in table IA and shall apply over the full case operating temperature range.

3.4 Electrical test requirements. The electrical test requirements shall be the subgroups specified in table IIA. The electrical tests for each subgroup are defined in table IA.

3.5 Marking. The part shall be marked with the PIN listed in 1.2 herein. In addition, the manufacturer's PIN may also be marked. For packages where marking of the entire SMD PIN number is not feasible due to space limitations, the manufacturer has the option of not marking the "5962-" on the device. For RHA product using this option, the RHA designator shall still be marked. Marking for device classes Q and V shall be in accordance with MIL-PRF-38535.

3.5.1 Certification/compliance mark. The certification mark for device classes Q and V shall be a "QML" or "Q" as required in MIL-PRF-38535.

3.6 Certificate of compliance. For device classes Q and V, a certificate of compliance shall be required from a QML-38535 listed manufacturer in order to supply to the requirements of this drawing (see 6.6.1 herein). The certificate of compliance submitted to DLA Land and Maritime-VA prior to listing as an approved source of supply for this drawing shall affirm that the manufacturer's product meets, for device classes Q and V.

3.7 Certificate of conformance. A certificate of conformance as required for device classes Q and V in MIL-PRF-38535 shall be provided with each lot of microcircuits delivered to this drawing.

STANDARD MICROCIRCUIT DRAWING DLA LAND AND MARITIME COLUMBUS, OHIO 43218-3990	SIZE A		5962-96571
		REVISION LEVEL G	SHEET 5

TABLE IA. Electrical performance characteristics.

Test	Symbol	Test conditions <u>1/</u> -55°C ≤ T _C ≤ +125°C unless otherwise specified	Device type	V _{DD}	Group A subgroups	Limits <u>2/</u>		Unit
						Min	Max	
High level input voltage	V _{IH}	M, D, P, L, R, F, G, H <u>3/</u>	All	4.5 V	1, 2, 3	2.25		V
			All		1	2.25		
			All	5.5 V	1, 2, 3	2.75		
			All		1	2.75		
Low level input voltage	V _{IL}	M, D, P, L, R, F, G, H <u>3/</u>	All	4.5 V	1, 2, 3		0.8	V
			All		1		0.8	
			All	5.5 V	1, 2, 3		0.8	
			All		1		0.8	
High level output voltage	V _{OH}	For all inputs affecting output under test, V _{IN} = V _{DD} or V _{SS} I _{OH} = -12.0 mA M, D, P, L, R, F, G, H <u>3/</u>	All	4.5 V	1, 2, 3	3.15		V
			All		1	3.15		
Low level output voltage	V _{OL}	For all inputs affecting output under test, V _{IN} = V _{DD} or V _{SS} I _{OL} = 12.0 mA M, D, P, L, R, F, G, H <u>3/</u>	All	4.5 V	1, 2, 3		0.4	V
			All		1		0.4	
Input current high	I _{IH}	For input under test, V _{IN} = V _{DD} For all other inputs, V _{IN} = V _{DD} or V _{SS} M, D, P, L, R, F, G, H <u>3/</u>	All	5.5 V	1, 2, 3		+1.0	μA
			All		1		+1.0	
Input current low	I _{IL}	For input under test, V _{IN} = V _{SS} For all other inputs, V _{IN} = V _{DD} or V _{SS} M, D, P, L, R, F, G, H <u>3/</u>	All	5.5 V	1, 2, 3		-1.0	μA
			All		1		-1.0	
Output current (source)	I _{OH} <u>4/</u>	For output under test, V _{OUT} = V _{DD} - 0.4 V V _{IN} = V _{DD} or V _{SS} M, D, P, L, R, F, G, H <u>3/</u>	All	4.5 V and 5.5 V	1, 2, 3	-12.0		mA
			All		1	-12.0		
Output current (sink)	I _{OL} <u>4/</u>	For output under test, V _{OUT} = 0.4 V V _{IN} = V _{DD} or V _{SS} M, D, P, L, R, F, G, H <u>3/</u>	All	4.5 V and 5.5 V	1, 2, 3	12.0		mA
			All		1	12.0		
Quiescent supply current	I _{DDQ}	V _{IN} = V _{DD} or V _{SS} Max rated RHA <u>3/</u>	All	5.5 V	1, 2, 3		10.0	μA
			All		1		50.0	
Quiescent supply current delta, TTL input levels	ΔI _{DDQ} <u>5/</u>	For input under test, V _{IN} = V _{DD} - 2.1 V For all other inputs, V _{IN} = V _{DD} or V _{SS} M, D, P, L, R, F, G, H <u>3/</u>	All	5.5 V	1, 2, 3		1.6	mA
			All		1		1.6	
Short circuit output current	I _{OS} <u>6/ 7/</u>	V _{OUT} = V _{DD} and V _{SS}	All	5.5 V	1, 2, 3		±300	mA

See footnotes at end of table.

**STANDARD
MICROCIRCUIT DRAWING**
DLA LAND AND MARITIME
COLUMBUS, OHIO 43218-3990

SIZE
A

REVISION LEVEL
G

5962-96571

SHEET
6

TABLE IA. Electrical performance characteristics – Continued.

Test	Symbol	Test conditions ^{1/} -55°C ≤ T _C ≤ +125°C unless otherwise specified	Device type	V _{DD}	Group A subgroups	Limits ^{2/}		Unit
						Min	Max	
Three-state output leakage current, high	I _{OZH}	$\overline{mG} = 5.5 \text{ V}$ For all other inputs, V _{IN} = V _{DD} or V _{SS} V _{OUT} = V _{DD}	All	5.5 V	1, 2, 3		+30.0	μA
			M, D, P, L, R, F, G, H ^{3/}			All	1	
Three-state output leakage current, low	I _{OZL}	$\overline{mG} = 5.5 \text{ V}$ For all other inputs, V _{IN} = V _{DD} or V _{SS} V _{OUT} = V _{SS}	All	5.5 V	1, 2, 3		-30.0	μA
			M, D, P, L, R, F, G, H ^{3/}			All	1	
Input capacitance	C _{IN}	f = 1 MHz See 4.4.1c	All	0.0 V	4		15.0	pF
Output capacitance	C _{OUT}	f = 1 MHz See 4.4.1c	All	0.0 V	4		15.0	pF
Switching power dissipation	P _{SW} ^{8/}	C _L = 50 pF, per switching output	All	4.5 V and 5.5 V	4, 5, 6		2.0	mW/MHz
			M, D, P, L, R, F, G, H ^{3/}			All	4	
Functional test	^{9/}	V _{IH} = 0.5 V _{DD} , V _{IL} = 0.8 V See 4.4.1b	All	4.5 V and 5.5 V	7, 8	L	H	
			M, D, P, L, R, F, G, H ^{3/}			All	7	
Propagation delay time, mAn to mYn	t _{PLH} ^{10/}	C _L = 50 pF minimum See figure 4	All	4.5 V and 5.5 V	9, 10, 11	1.0	11.0	ns
			M, D, P, L, R, F, G, H ^{3/}			All	9	
	t _{PHL} ^{10/}	C _L = 50 pF minimum See figure 4	All	4.5 V and 5.5 V	9, 10, 11	1.0	11.0	
			M, D, P, L, R, F, G, H ^{3/}			All	9	
Propagation delay time, output enable, \overline{mG} to mYn	t _{PZH} ^{10/}	C _L = 50 pF minimum See figure 4	All	4.5 V and 5.5 V	9, 10, 11	2.0	12.0	ns
			M, D, P, L, R, F, G, H ^{3/}			All	9	
	t _{PZL} ^{10/}	C _L = 50 pF minimum See figure 4	All	4.5 V and 5.5 V	9, 10, 11	2.0	12.0	
			M, D, P, L, R, F, G, H ^{3/}			All	9	
Propagation delay time, output disable, \overline{mG} to mYn	t _{PHZ} ^{10/}	C _L = 50 pF minimum See figure 4	All	4.5 V and 5.5 V	9, 10, 11	2.0	12.0	ns
			M, D, P, L, R, F, G, H ^{3/}			All	9	
	t _{PLZ} ^{10/}	C _L = 50 pF minimum See figure 4	All	4.5 V and 5.5 V	9, 10, 11	2.0	12.0	
			M, D, P, L, R, F, G, H ^{3/}			All	9	

^{1/} Each input/output, as applicable, shall be tested at the specified temperature, for the specified limits, to the tests in table IA herein. Output terminals not designated shall be high level logic, low level logic, or open, except for the I_{DDQ} and ΔI_{DDQ} tests, the output terminals shall be open. When performing the I_{DDQ} and ΔI_{DDQ} tests, the current meter shall be placed in the circuit such that all current flows through the meter.

STANDARD MICROCIRCUIT DRAWING DLA LAND AND MARITIME COLUMBUS, OHIO 43218-3990	SIZE A		5962-96571
		REVISION LEVEL G	SHEET 7

TABLE IA. Electrical performance characteristics – Continued.

- 2/ For negative and positive voltage and current values, the sign designates the potential difference in reference to V_{SS} and the direction of current flow, respectively; and the absolute value of the magnitude, not the sign, is relative to the minimum and maximum limits, as applicable, listed herein.
- 3/ RHA devices supplied to this drawing meet all levels M, D, P, L, R, F, G, and H of irradiation. However, these devices are only tested at the 'H' level. Each device type supplied to this drawing is guaranteed to comply with specification table IA through all RHA levels up to, and including, the maximum RHA level listed in section 1.5 Radiation features. Pre and post irradiation values are identical unless otherwise specified in table IA. When performing post irradiation electrical measurements for any RHA level, T_A=+25°C.
- 4/ This test is guaranteed based on characterization data but not tested.
- 5/ This test may be performed either one input at a time (preferred method) or with all input pins simultaneously at V_{IN} = V_{DD} - 2.1 V (alternate method). Classes Q and V shall use the preferred method. When the test is performed using the alternate test method, the maximum limit is equal to the number of inputs at a high TTL input level times 1.6 mA; and the preferred method and limits are guaranteed. For the preferred method, a minimum of one input shall be tested. All other inputs shall be guaranteed, if not tested, to the limits specified in table IA, herein.
- 6/ This parameter is supplied as design limit but not guaranteed or tested.
- 7/ No more than one output should be shorted at a time for a maximum duration of one second.
- 8/ This value is calculated during the design/qualification process and is supplied as a design limit but is not tested. Total power consumption is determined by both idle/standby power consumption (P_s) and "at frequency" power consumption (P_f). To determine standby power consumption, use the formula:

$$P_T = (n \times P_{SW} \times f) + (Loads \times Prdy \times I_{OL} \times V_{OL})$$
 where n is the number of switching outputs; f is the frequency of the device; loads is the resistive power component, typically a TTL load; and Prdy is the percent duty cycle that the output is sinking current.
- 9/ The test vectors used to verify the truth table shall, at a minimum, test all functions of each input and output. All possible input to output logic patterns per function shall be guaranteed, if not tested, to the truth table in figure 2 herein. For V_{OUT} measurements, L ≤ 0.5 V and H ≥ 4.0 V and are tested at V_{DD} = 4.5 V and 5.5 V.
- 10/ For propagation delay tests, all paths must be tested.

TABLE IB. SEP test limits. 1/ 2/

Device type	V _{DD} = 4.5 V for device type 01 <u>3/</u>		Bias V _{DD} = 5.5 V For SEL test <u>4/ 5/</u> No SEL occurs at effective LET
	No SEU occurs at effective LET	Maximum device cross section	
01	LET ≤ 80 MeV/(mg/cm ²)	6 x 10 ⁻⁹ cm ² /bit <u>6/</u>	LET ≤ 120 MeV/(mg/cm ²)

- 1/ For SEP test conditions, see 4.4.4.4 herein.
- 2/ Technology characterization and model verification supplemented by in-line data may be used in lieu of end-of-line testing. Test plan must be approved by TRB and qualifying activity.
- 3/ Tested for upsets at operating temperature, T_A = +25°C ± 10°C.
- 4/ Tested at operating temperature, T_A = +125°C ± 10°C for latch-up.
- 5/ Tested to a LET = 120 MeV/(mg/cm²) with no latch-up (SEL).
- 6/ The bit error cross section is established from a "hard" D flip-flop that is based on the Weibull distribution from SEU testing, and is performed on the Standard Evaluation Circuit (SEC).

STANDARD MICROCIRCUIT DRAWING DLA LAND AND MARITIME COLUMBUS, OHIO 43218-3990	SIZE A		5962-96571
		REVISION LEVEL G	SHEET 8

Device type	All
Case outlines	R and X
Terminal Number	Terminal symbol
1	$\overline{1G}$
2	1A1
3	2Y4
4	1A2
5	2Y3
6	1A3
7	2Y2
8	1A4
9	2Y1
10	V _{SS}
11	2A1
12	1Y4
13	2A2
14	1Y3
15	2A3
16	1Y2
17	2A4
18	1Y1
19	$\overline{2G}$
20	V _{DD}

FIGURE 1. Terminal connections.

STANDARD MICROCIRCUIT DRAWING DLA LAND AND MARITIME COLUMBUS, OHIO 43218-3990	SIZE A		5962-96571
		REVISION LEVEL G	SHEET 9

Inputs		Outputs
\overline{mG}	mAn	mYn
L	L	L
L	H	H
H	X	Z

H = High voltage level
L = Low voltage level
X = Don't care
Z = High impedance

FIGURE 2. Truth table.

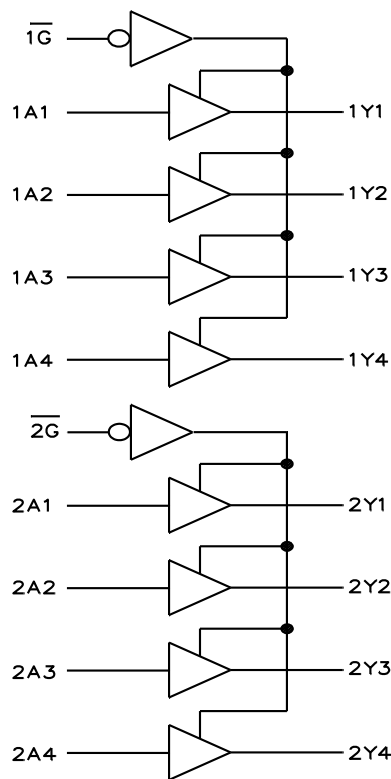

FIGURE 3. Logic diagram.

**STANDARD
MICROCIRCUIT DRAWING**
DLA LAND AND MARITIME
COLUMBUS, OHIO 43218-3990

SIZE
A

5962-96571

REVISION LEVEL
G

SHEET
10

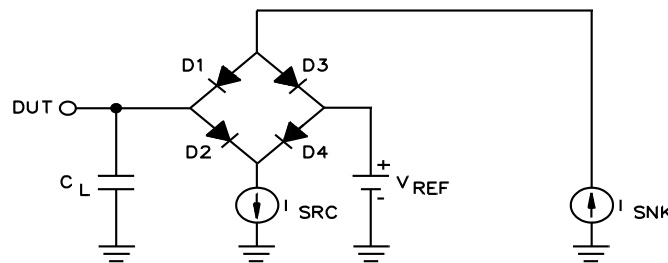
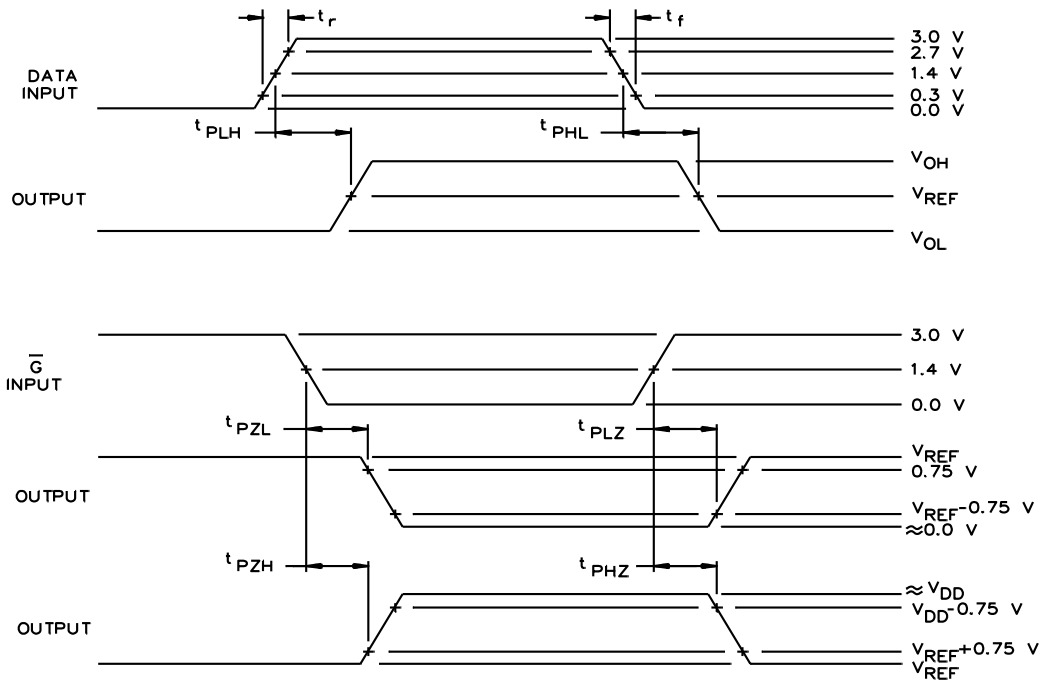

TEST CIRCUIT A
OR EQUIVALENT

NOTES:

1. $V_{REF} = 1.4 \text{ V}$.
2. $C_L = 50 \text{ pF}$ minimum or equivalent (includes test jig and probe capacitance).
3. I_{SRC} is set to -1.0 mA and I_{SNK} is set to 1.0 mA for t_{PHL} , t_{PLH} , t_{PZL} , and t_{PZH} measurements. I_{SRC} is set to -12.0 mA and I_{SNK} is set to 12.0 mA for t_{PLZ} and t_{PHZ} measurements.
4. Input signal from pulse generator: $V_{IN} = 0.0 \text{ V}$ to 3.0 V ; $f \leq 10 \text{ MHz}$; $t_r = 1.0 \text{ ns/V} \pm 0.3 \text{ ns/V}$; $t_f = 1.0 \text{ ns/V} \pm 0.3 \text{ ns/V}$; t_r and t_f shall be measured from 0.3 V to 2.7 V and from 2.7 V to 0.3 V , respectively.
5. Equivalent test circuit means that DUT performance will be correlated and remain guaranteed to the applicable test circuit, above, whenever a test platform change necessitates a deviation from the applicable test circuit.

FIGURE 4. Switching waveforms and test circuit.

STANDARD MICROCIRCUIT DRAWING DLA LAND AND MARITIME COLUMBUS, OHIO 43218-3990	SIZE A		5962-96571
		REVISION LEVEL G	SHEET 11

4. VERIFICATION

4.1 Sampling and inspection. For device classes Q and V, sampling and inspection procedures shall be in accordance with MIL-PRF-38535 or as modified in the device manufacturer's Quality Management (QM) plan. The modification in the QM plan shall not affect the form, fit, or function as described herein.

4.2 Screening. For device classes Q and V, screening shall be in accordance with MIL-PRF-38535, and shall be conducted on all devices prior to qualification and technology conformance inspection.

4.2.1 Additional criteria for device classes Q and V.

- a. The burn-in test duration, test condition and test temperature, or approved alternatives shall be as specified in the device manufacturer's QM plan in accordance with MIL-PRF-38535. The burn-in test circuit shall be maintained under document revision level control of the device manufacturer's Technology Review Board (TRB) in accordance with MIL-PRF-38535 and shall be made available to the acquiring or preparing activity upon request. The test circuit shall specify the inputs, outputs, biases, and power dissipation, as applicable, in accordance with the intent specified in method 1015 of MIL-STD-883.
- b. Interim and final electrical test parameters shall be as specified in table IIA herein.
- c. Additional screening for device class V beyond the requirements of device class Q shall be as specified in MIL-PRF-38535, appendix B or as modified in the device manufacturer's Quality Management (QM) plan.

4.3 Qualification inspection for device classes Q and V. Qualification inspection for device classes Q and V shall be in accordance with MIL-PRF-38535. Inspections to be performed shall be those specified in MIL-PRF-38535 and herein for groups A, B, C, D, and E inspections (see 4.4.1 through 4.4.4).

4.4 Conformance inspection. Technology conformance inspection for classes Q and V shall be in accordance with MIL-PRF-38535 including groups A, B, C, D, and E inspections and as specified herein (see 4.4.1 through 4.4.4).

4.4.1 Group A inspection.

- a. Tests shall be as specified in table IIA herein.
- b. For device classes Q and V, subgroups 7 and 8 shall include verifying the functionality of the device.
- c. C_{IN} and C_{OUT} shall be measured only for initial qualification and after process or design changes which may affect capacitance. C_{IN} shall be measured between the designated terminal and V_{SS} at a frequency of 1 MHz. For C_{IN} and C_{OUT}, test all applicable pins on five devices with zero failures.

4.4.2 Group C inspection. The group C inspection end-point electrical parameters shall be as specified in table IIA herein.

4.4.2.1 Additional criteria for device classes Q and V. The steady-state life test duration, test condition and test temperature, or approved alternatives shall be as specified in the device manufacturer's QM plan in accordance with MIL-PRF-38535. The test circuit shall be maintained under document revision level control by the device manufacturer's TRB in accordance with MIL-PRF-38535 and shall be made available to the acquiring or preparing activity upon request. The test circuit shall specify the inputs, outputs, biases, and power dissipation, as applicable, in accordance with the intent specified in method 1005 of MIL-STD-883.

4.4.3 Group D inspection. The group D inspection end-point electrical parameters shall be as specified in table IIA herein.

STANDARD MICROCIRCUIT DRAWING DLA LAND AND MARITIME COLUMBUS, OHIO 43218-3990	SIZE A		5962-96571
		REVISION LEVEL G	SHEET 12

TABLE IIA. Electrical test requirements.

Test requirements	Subgroups (in accordance with MIL-PRF-38535, table III)	
	Device class Q	Device class V
Interim electrical parameters (see 4.2)	1, 7, 9	1, 7, 9
Final electrical parameters (see 4.2)	1, 2, 3, 7, 8, 9, 10, 11 <u>1/</u>	1, 2, 3, 7, 8, 9, 10, 11 <u>2/ 3/</u>
Group A test requirements (see 4.4)	1, 2, 3, 4, 5, 6, 7, 8, 9, 10, 11	1, 2, 3, 4, 5, 6, 7, 8, 9, 10, 11
Group C end-point electrical parameters (see 4.4)	1, 2, 3, 7, 8, 9, 10, 11	1, 2, 3, 7, 8, 9, 10, 11 <u>3/</u>
Group D end-point electrical parameters (see 4.4)	1, 7, 9	1, 2, 3, 7, 9
Group E end-point electrical parameters (see 4.4)	1, 7, 9	1, 7, 9

1/ PDA applies to subgroups 1 and 7.

2/ PDA applies to subgroups 1, 7, and deltas.

3/ Delta limits, as specified in table IIB, shall be required where specified, and the delta values shall be completed with reference to the zero hour electrical parameters.

TABLE IIB. Burn-in and operating life test, delta parameters (+25°C).

Parameters	Symbol	Delta limits
Output voltage low	V _{OL}	±100 mV
Output voltage high	V _{OH}	±100 mV

**STANDARD
MICROCIRCUIT DRAWING**
DLA LAND AND MARITIME
COLUMBUS, OHIO 43218-3990

SIZE
A

REVISION LEVEL
G

5962-96571

SHEET
13

4.4.4 Group E inspection. Group E inspection is required only for parts intended to be marked as radiation hardness assured (see 3.5 herein).

- a. End-point electrical parameters shall be as specified in table IIA herein.
- b. For device classes Q and V, the devices or test vehicle shall be subjected to radiation hardness assured tests as specified in MIL-PRF-38535 for the RHA level being tested. All device classes must meet the postirradiation end-point electrical parameter limits as defined in table IA at $T_A = +25^{\circ}\text{C} \pm 5^{\circ}\text{C}$, after exposure, to the subgroups specified in table IIA herein.

4.4.4.1 Total dose irradiation testing. Total dose irradiation testing shall be performed in accordance with MIL-STD-883 method 1019, condition A, and as specified herein.

4.4.4.1.1 Accelerated annealing test. Accelerated annealing tests shall be performed on all devices requiring a RHA level greater than 5k Rad (Si). The post-anneal end-point electrical parameter limits shall be as specified in table IA herein and shall be the pre-irradiation end-point electrical parameter limit at $25^{\circ}\text{C} \pm 5^{\circ}\text{C}$. Testing shall be performed at initial qualification and after any design or process changes which may affect the RHA response of the device.

4.4.4.2 Dose rate induced latchup testing. When required by the customer, dose rate induced latchup testing shall be performed in accordance with method 1020 of MIL-STD-883 and as specified herein. Tests shall be performed on devices, SEC, or approved test structures at technology qualification and after any design or process changes which may affect the RHA capability of the process.

4.4.4.3 Dose rate upset testing. When required by the customer, dose rate upset testing shall be performed in accordance with method 1021 of MIL-STD-883 and herein.

- a. Transient dose rate upset testing shall be performed at initial qualification and after any design or process change which may affect the RHA performance of the devices. Test 10 devices with 0 defects unless otherwise specified.
- b. Transient dose rate upset testing for class Q and V devices shall be performed as specified by a TRB approved radiation hardness assurance plan and MIL-PRF-38535. Device parametric parameters that influence upset immunity shall be monitored at the wafer level in accordance with the wafer level hardness assurance plan and MIL-PRF-38535.

4.4.4.4 Single event phenomena (SEP). When specified in the purchase order or contract, SEP testing shall be performed on class V devices. SEP testing shall be performed on the Standard Evaluation Circuit (SEC) or alternate SEP test vehicle as approved by the qualifying activity at initial qualification and after any design or process changes which may affect the upset or latchup characteristics. Test four devices with zero failures. ASTM F1192 may be used as a guideline when performing SEP testing. The test conditions for SEP are as follows:

- a. The ion beam angle of incidence shall be between normal to the die surface and 60° to the normal, inclusive (i.e. $0^{\circ} \leq \text{angle} \leq 60^{\circ}$). No shadowing of the ion beam due to fixturing or package related affects is allowed.
- b. The fluence shall be ≥ 100 errors or $\geq 10^7$ ions/cm².
- c. The flux shall be between 10^2 and 10^6 ions/cm²/s. The cross-section shall be verified to be flux independent by measuring the cross-section at two flux rates which differ by at least an order of magnitude.
- d. The particle range shall be ≥ 20 micron in silicon.
- e. The test temperature shall be $+25^{\circ}\text{C}$ for the upset measurements and the maximum rated operating temperature $\pm 10^{\circ}\text{C}$ for the latchup measurements.
- f. Bias conditions shall be defined by the manufacturer for the latchup measurements.
- g. For SEP test limits, see table IB herein.

STANDARD MICROCIRCUIT DRAWING DLA LAND AND MARITIME COLUMBUS, OHIO 43218-3990	SIZE A		5962-96571
		REVISION LEVEL G	SHEET 14

4.5 Methods of inspection. Methods of inspection shall be specified as follows:

4.5.1 Voltage and current. Unless otherwise specified, all voltages given are referenced to the microcircuit V_{SS} terminal. Currents given are conventional current and positive when flowing into the referenced terminal.

5. PACKAGING

5.1 Packaging requirements. The requirements for packaging shall be in accordance with MIL-PRF-38535 for device classes Q and V.

6. NOTES

6.1 Intended use. Microcircuits conforming to this drawing are intended for use for Government microcircuit applications (original equipment), design applications, and logistics purposes.

6.1.1 Replaceability. Microcircuits covered by this drawing will replace the same generic device covered by a contractor-prepared specification or drawing.

6.1.2 Substitutability. Device class Q devices will replace device class M devices.

6.2 Configuration control of SMD's. All proposed changes to existing SMD's will be coordinated with the users of record for the individual documents. This coordination will be accomplished using DD Form 1692, Engineering Change Proposal.

6.3 Record of users. Military and industrial users should inform DLA Land and Maritime when a system application requires configuration control and which SMD's are applicable to that system. DLA Land and Maritime will maintain a record of users and this list will be used for coordination and distribution of changes to the drawings. Users of drawings covering microelectronic devices (FSC 5962) should contact DLA Land and Maritime -VA, telephone (614) 692-8108.

6.4 Comments. Comments on this drawing should be directed to DLA Land and Maritime -VA, Columbus, Ohio 43218-3990, or telephone (614) 692-0540.

6.5 Abbreviations, symbols, and definitions. The abbreviations, symbols, and definitions used herein are defined in MIL-PRF-38535 and MIL-HDBK-1331.

6.6 Sources of supply.

6.6.1 Sources of supply for device classes Q and V. Sources of supply for device classes Q and V are listed in QML-38535. The vendors listed in QML-38535 have submitted a certificate of compliance (see 3.6 herein) to DLA Land and Maritime -VA and have agreed to this drawing.

6.7 Additional information. A copy of the following additional data shall be maintained and available from the device manufacturer:

- a. RHA test conditions (SEP).
- b. Number of upsets (SEU).
- c. Number of transients (SET).
- d. Occurrence of latch-up (SEL).

STANDARD MICROCIRCUIT DRAWING DLA LAND AND MARITIME COLUMBUS, OHIO 43218-3990	SIZE A		5962-96571
		REVISION LEVEL G	SHEET 15

APPENDIX A
APPENDIX A FORMS A PART OF SMD 5962-96571

A.1 SCOPE

A.1.1 Scope. This appendix establishes minimum requirements for microcircuit die to be supplied under the Qualified Manufacturers List (QML) Program. QML microcircuit die meeting the requirements of MIL-PRF-38535 and the manufacturers approved QM plan for use in monolithic microcircuits, multi-chip modules (MCMs), hybrids, electronic modules, or devices using chip and wire designs in accordance with MIL-PRF-38534 are specified herein. Two product assurance classes consisting of military high reliability (device class Q) and space application (device class V) are reflected in the Part or Identification Number (PIN). When available, a choice of Radiation Hardness Assurance (RHA) levels is reflected in the PIN.

A.1.2 PIN. The PIN is as shown in the following example:

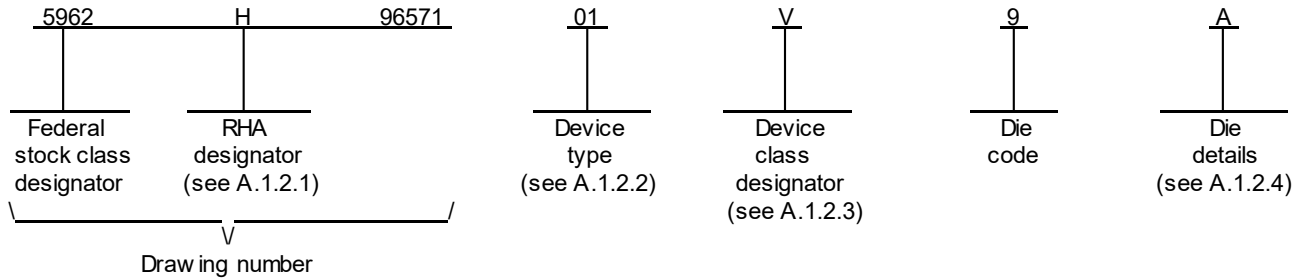

A.1.2.1 RHA designator. Device classes Q and V RHA identified die meet the MIL-PRF-38535 specified RHA levels. A dash (-) indicates a non-RHA die.

A.1.2.2 Device type(s). The device type(s) identify the circuit function as follows:

<u>Device type</u>	<u>Generic number</u>	<u>Circuit function</u>
01	54ACTS244	Radiation hardened, octal buffer/line driver with three-state outputs, TTL compatible inputs

A.1.2.3 Device class designator. Device class Q designator will not be included in the PIN and will not be marked on the device since the device class designator has been added after the original issuance of this drawing.

<u>Device class</u>	<u>Device requirements documentation</u>
Q or V	Certification and qualification to the die requirements of MIL-PRF-38535

STANDARD MICROCIRCUIT DRAWING DLA LAND AND MARITIME COLUMBUS, OHIO 43218-3990	SIZE A		5962-96571
		REVISION LEVEL G	SHEET 16

APPENDIX A
APPENDIX A FORMS A PART OF SMD 5962-96571

A.1.2.4 Die details. The die details designation is a unique letter which designates the die's physical dimensions, bonding pad location(s) and related electrical function(s), interface materials, and other assembly related information, for each product and variant supplied to this appendix.

A.1.2.4.1 Die physical dimensions.

<u>Die type</u>	<u>Figure number</u>
01	A-1, B-1

A.1.2.4.2 Die bonding pad locations and electrical functions.

<u>Die type</u>	<u>Figure number</u>
01	A-1, B-1

A.1.2.4.3 Interface materials.

<u>Die type</u>	<u>Figure number</u>
01	A-1, B-1

A.1.2.4.4 Assembly related information.

<u>Die type</u>	<u>Figure number</u>
01	A-1, B-1

A.1.3 Absolute maximum ratings. See paragraph 1.3 herein for details.

A.1.4 Recommended operating conditions. See paragraph 1.4 herein for details.

STANDARD MICROCIRCUIT DRAWING DLA LAND AND MARITIME COLUMBUS, OHIO 43218-3990	SIZE A		5962-96571
		REVISION LEVEL G	SHEET 17

APPENDIX A
APPENDIX A FORMS A PART OF SMD 5962-96571

A.2 APPLICABLE DOCUMENTS

A.2.1 Government specification, standards, and handbooks. The following specification, standard, and handbooks form a part of this drawing to the extent specified herein. Unless otherwise specified, the issues of these documents are those cited in the solicitation or contract.

DEPARTMENT OF DEFENSE SPECIFICATION

MIL-PRF-38535 - Integrated Circuits, Manufacturing, General Specification for.

DEPARTMENT OF DEFENSE STANDARD

MIL-STD-883 - Test Method Standard Microcircuits.

DEPARTMENT OF DEFENSE HANDBOOKS

MIL-HDBK-103 - List of Standard Microcircuit Drawings.
MIL-HDBK-780 - Standard Microcircuit Drawings.

(Copies of these documents are available online at <https://quicksearch.dla.mil/>.)

A.2.2 Order of precedence. In the event of a conflict between the text of this drawing and the references cited herein, the text of this drawing takes precedence. Nothing in this document, however, supersedes applicable laws and regulations unless a specific exemption has been obtained.

A.3 REQUIREMENTS

A.3.1 Item requirements. The individual item requirements for device classes Q and V shall be in accordance with MIL-PRF-38535 and as specified herein or as modified in the device manufacturer's Quality Management (QM) plan. The modification in the QM plan shall not affect the form, fit, or function as described herein.

A.3.2 Design, construction and physical dimensions. The design, construction, and physical dimensions shall be as specified in MIL-PRF-38535 and herein and the manufacturer's QM plan for device classes Q and V.

A.3.2.1 Die physical dimensions. The die physical dimensions shall be as specified in A.1.2.4.1 and on figure A-1, B-1.

A.3.2.2 Die bonding pad locations and electrical functions. The die bonding pad locations and electrical functions shall be as specified in A.1.2.4.2 and on figure A-1, B-1.

A.3.2.3 Interface materials. The interface materials for the die shall be as specified in A.1.2.4.3 and on figure A-1, B-1.

A.3.2.4 Assembly related information. The assembly related information shall be as specified in A.1.2.4.4 and on figure A-1, B-1.

A.3.2.5 Truth table. The truth table shall be as defined in paragraph 3.2.3 herein.

A.3.2.6 Radiation exposure circuit. The radiation exposure circuit shall be as defined in paragraph 3.2.6 herein.

A.3.3 Electrical performance characteristics and post-irradiation parameter limits. Unless otherwise specified herein, the electrical performance characteristics and post-irradiation parameter limits are as specified in table IA of the body of this document.

A.3.4 Electrical test requirements. The wafer probe test requirements shall include functional and parametric testing sufficient to make the packaged die capable of meeting the electrical performance requirements in table IA.

STANDARD MICROCIRCUIT DRAWING DLA LAND AND MARITIME COLUMBUS, OHIO 43218-3990	SIZE A		5962-96571
		REVISION LEVEL G	SHEET 18

APPENDIX A
APPENDIX A FORMS A PART OF SMD 5962-96571

A.3.5 Marking. As a minimum, each unique lot of die, loaded in single or multiple stack of carriers, for shipment to a customer, shall be identified with the wafer lot number, the certification mark, the manufacturer's identification and the PIN listed in A.1.2 herein. The certification mark shall be a "QML" or "Q" as required by MIL-PRF-38535.

A.3.6 Certification of compliance. For device classes Q and V, a certificate of compliance shall be required from a QML-38535 listed manufacturer in order to supply to the requirements of this drawing (see A.6.4 herein). The certificate of compliance submitted to DLA Land and Maritime-VA prior to listing as an approved source of supply for this appendix shall affirm that the manufacturer's product meets, for device classes Q and V, the requirements of MIL-PRF-38535 and the requirements herein.

A.3.7 Certificate of conformance. A certificate of conformance as required for device classes Q and V in MIL-PRF-38535 shall be provided with each lot of microcircuit die delivered to this drawing.

A.4 VERIFICATION

A.4.1 Sampling and inspection. For device classes Q and V, die sampling and inspection procedures shall be in accordance with MIL-PRF-38535 or as modified in the device manufacturer's Quality Management (QM) plan. The modifications in the QM plan shall not affect the form, fit, or function as described herein.

A.4.2 Screening. For device classes Q and V, screening shall be in accordance with MIL-PRF-38535, and as defined in the manufacturer's QM plan. As a minimum, it shall consist of:

- a. Wafer lot acceptance for class V product using the criteria defined in MIL-STD-883, method 5007.
- b. 100% wafer probe (see paragraph A.3.4 herein).
- c. 100% internal visual inspection to the applicable class Q or V criteria defined in MIL-STD-883, method 2010 or the alternate procedures allowed in MIL-STD-883, method 5004.

A.4.3 Conformance inspection.

A.4.3.1 Group E inspection. Group E inspection is required only for parts intended to be identified as radiation assured (see A.3.5 herein). RHA levels for device classes Q and V shall be as specified in MIL-PRF-38535. End point electrical testing of packaged die shall be as specified in table IIA herein. Group E tests and conditions are as specified in paragraphs 4.4.4 herein.

A.5 DIE CARRIER

A.5.1 Die carrier requirements. The requirements for the die carrier shall be accordance with the manufacturer's QM plan or as specified in the purchase order by the acquiring activity. The die carrier shall provide adequate physical, mechanical and electrostatic protection.

A.6 NOTES

A.6.1 Intended use. Microcircuit die conforming to this drawing are intended for use in microcircuits built in accordance with MIL-PRF-38535 or MIL-PRF-38534 for government microcircuit applications (original equipment), design applications, and logistics purposes.

A.6.2 Comments. Comments on this appendix should be directed to DLA Land and Maritime-VA, Columbus, Ohio, 43218-3990 or telephone (614) 692-0540.

A.6.3 Abbreviations, symbols, and definitions. The abbreviations, symbols, and definitions used herein are defined in MIL-PRF-38535 and MIL-HDBK-1331.

A.6.4 Sources of supply for device classes Q and V. Sources of supply for device classes Q and V are listed in QML-38535. The vendors listed within QML-38535 have submitted a certificate of compliance (see A.3.6 herein) to DLA Land and Maritime-VA and have agreed to this drawing.

STANDARD MICROCIRCUIT DRAWING DLA LAND AND MARITIME COLUMBUS, OHIO 43218-3990	SIZE A		5962-96571
		REVISION LEVEL G	SHEET 19

APPENDIX A
APPENDIX A FORMS A PART OF SMD 5962-96571

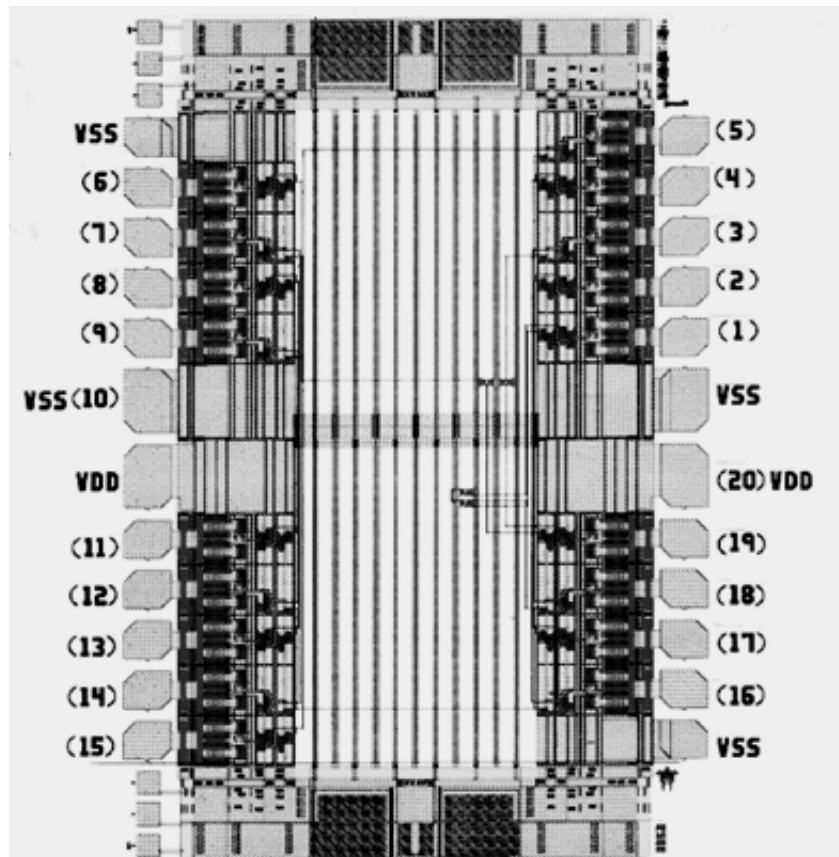

NOTE: Pad numbers reflect terminal numbers when placed in case outlines R and X (see figure 1).

FIGURE A-1 Die bonding pad locations and electrical functions.

STANDARD MICROCIRCUIT DRAWING DLA LAND AND MARITIME COLUMBUS, OHIO 43218-3990	SIZE A		5962-96571
		REVISION LEVEL G	SHEET 20

APPENDIX A
APPENDIX A FORMS A PART OF SMD 5962-96571

Die physical dimensions.

Die size: 111 x 81 mils
Die thickness: 17 ±1 mils

Interface materials.

Top metallization: Si Al Cu
Thickness 9.0 kÅ – 12.5 kÅ
Backside metallization: None
Glassivation.
Type: Phosphorous Doped SiO₂
Thickness: 9.0 kÅ – 11.0 kÅ
Substrate: Epitaxial Layer on Single Crystal Silicon

Assembly related information.

Substrate potential: Tied to V_{DD}
Special assembly instructions: Bond pad #20 (V_{DD}) first
Do not wire bond the six probe ID pads

FIGURE A-1 Die bonding pad locations and electrical functions - Continued.

STANDARD MICROCIRCUIT DRAWING DLA LAND AND MARITIME COLUMBUS, OHIO 43218-3990	SIZE A		5962-96571
		REVISION LEVEL G	SHEET 21

APPENDIX A
 APPENDIX A FORMS A PART OF SMD 5962-96571

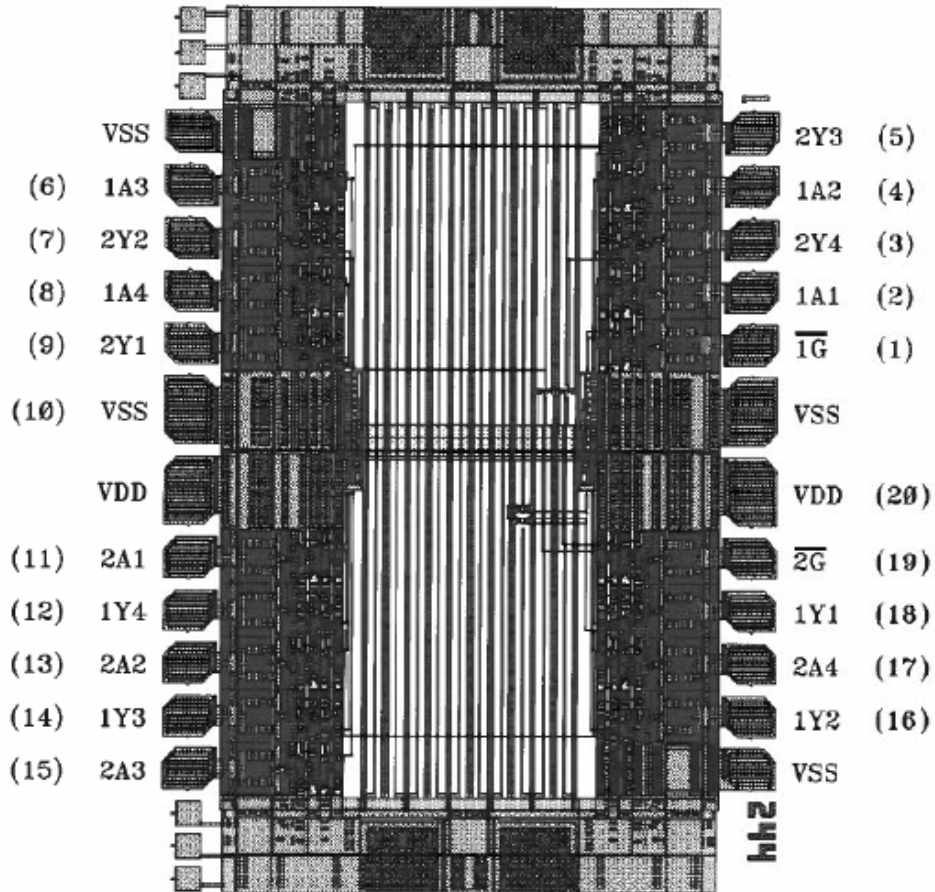

NOTE: Pad numbers reflect terminal numbers when placed in case outline X (see figure 1).

FIGURE B-1 Die bonding pad locations and electrical functions.

STANDARD MICROCIRCUIT DRAWING DLA LAND AND MARITIME COLUMBUS, OHIO 43218-3990	SIZE A		5962-96571
		REVISION LEVEL G	SHEET 22

APPENDIX A
APPENDIX A FORMS A PART OF SMD 5962-96571

Die physical dimensions.

Die size: 111 x 81 mils
Die thickness: 17 ±1 mils

Interface materials.

Top metallization: Si Al Cu
Thickness 9.0 kÅ – 12.5 kÅ
Backside metallization: None
Glassivation.
Type: Nitride
Thickness: 9.0 kÅ – 11.0 kÅ
Substrate: Epitaxial Layer on Single Crystal Silicon

Assembly related information.

Substrate potential: Tied to V_{ss}
Special assembly instructions: Bond pad #10 (V_{ss}) first
Do not wire bond the six probe ID pads

FIGURE B-1 Die bonding pad locations and electrical functions - Continued.

STANDARD MICROCIRCUIT DRAWING DLA LAND AND MARITIME COLUMBUS, OHIO 43218-3990	SIZE A		5962-96571
		REVISION LEVEL G	SHEET 23

STANDARD MICROCIRCUIT DRAWING BULLETIN

DATE: 20-09-18

Approved sources of supply for SMD 5962-96571 are listed below for immediate acquisition information only and shall be added to MIL-HDBK-103 and QML-38535 during the next revision. MIL-HDBK-103 and QML-38535 will be revised to include the addition or deletion of sources. The vendors listed below have agreed to this drawing and a certificate of compliance has been submitted to and accepted by DLA Land and Maritime-VA. This information bulletin is superseded by the next dated revision of MIL-HDBK-103 and QML-38535. DLA Land and Maritime maintains an online database of all current sources of supply at <https://landandmaritimeapps.dla.mil/Programs/Smcr/>.

Standard microcircuit drawing PIN <u>1/</u>	Vendor CAGE Number	Vendor similar PIN <u>2/</u>
5962H9657101VRA	<u>3/</u>	UT54ACTS244PVAH
5962H9657101VXA	<u>3/</u>	UT54ACTS244UVAH
5962H9657101VRC	<u>3/</u>	UT54ACTS244PVCH
5962H9657101VXC	<u>3/</u>	UT54ACTS244UVCH
5962H9657101QRA	<u>3/</u>	UT54ACTS244PQAH
5962H9657101QXA	<u>3/</u>	UT54ACTS244UQAH
5962H9657101QRC	<u>3/</u>	UT54ACTS244PQCH
5962H9657101QXC	<u>3/</u>	UT54ACTS244UQCH
5962H9657101V9A	<u>3/</u>	UT54ACTS244-V-DIEH
5962H9657101Q9A	<u>3/</u>	UT54ACTS244-Q-DIEH
5962G9657101VXA	65342	UT54ACTS244UVAG
5962G9657101VXC	65342	UT54ACTS244UVCG
5962G9657101QXA	65342	UT54ACTS244UQAG
5962G9657101QXC	65342	UT54ACTS244UQCG
5962G9657101V9B	65342	UT54ACTS244-V-DIEG
5962G9657101Q9B	65342	UT54ACTS244-G-DIEG

- 1/ The lead finish shown for each PIN representing a hermetic package is the most readily available from the manufacturer listed for that part. If the desired lead finish is not listed, contact the vendor to determine its availability.
- 2/ Caution. Do not use this number for item acquisition. Items acquired to this number may not satisfy the performance requirements of this drawing.
- 3/ Not available from an approved source and supply.

Vendor CAGE
number

65342

Vendor name
and address

Cobham Colorado Springs, Inc.
4350 Centennial Boulevard
Colorado Springs, CO 80907-3486

The information contained herein is disseminated for convenience only and the Government assumes no liability whatsoever for any inaccuracies in the information bulletin.